

# FISHMAN® ACOUSTIC MATRIX™ PROFESSIONAL SYSTEM PREAMP INSTALLATION

## PARTS LIST

- Slider Bezel
- Acoustic Matrix Pickup
- 4-40 Screws (4), 3/16" length, with Star Washers
- 1/4" Aluminum Hex Standoffs (4), 9/16" length
- (3) Adhesive-backed Plastic Wire Guides
- (5) Slider Knobs
- Preamp
- 1/4" Stereo Jack, with hardware
- 4-40 Screws (4), 7/16" length
- 3/16" Brass Hex Jack Screws (4), 1/2" length
- Preamp Cutout Template
- Back Plate with Battery Clip

## TOOLS

- Caliper
- Router with 1/8" (3 mm) (or .9375" Plunging Cutter for Narrow Format)
- 400 Grit Sandpaper or Scraper
- Flex Shaft Tool with 1" (25.4 mm) Diameter Saw Blade or Router with 1/4" (6.30 mm) cutter.
- Soldering Iron (30 watt max)
- Wire Strippers
- Variable Speed Drill
- 1/8" Twist Drill
- 1/2" Open End Wrench
- Rosin Core Solder
- #1 Phillips Screwdriver
- Center Punch
- 15/32" Spade Bit Drill
- 3/32" Allen Wrench

## PICKUP DIMENSIONS

### WIDE Format

Width:	.125" (3.2 mm)
Height:	.053" (1.35 mm)
Length:	2.650" (67.3 mm)
Sensing Area:	2.670" (67.8 mm)
Max. recommended string spacing:	2.500" (63.5 mm)

### Narrow Format

Width:	.09375" (2.4 mm)
Height:	.043" (1.1 mm)
Length:	2.650" (67.3 mm)
Sensing Area:	2.670" (67.8 mm)
Max. recommended string spacing:	2.500" (63.5 mm)

**NOTE:** The overall length of the Matrix pickup is 2.700" (68.58mm). We recommend a saddle slot length of at least 2.875" (73mm).

The actual sensing area of the pickup is 2.670" long and can accommodate string spacings of up to 2.500" (63.5 mm). Poor string balance may result with string spacings greater than this.

DO NOT trim the end of the pickups length as ground hum will occur. Custom pickup lengths are available from Fishman.

## MECHANICAL FACTORS AFFECTING PICKUP PERFORMANCE

### BREAK ANGLE

There must be an adequate amount of downbearing pressure on the pickup in order for it to perform optimally. The pickup will "see" an acceptable amount of downbearing pressure when there is a 20° (minimum) break angle across the saddle.

A pickup in a Guitar with less than a 20° break angle will often have string balance problems as well as poor tone. For such instruments, an adequate break angle can be realized by "ramping" the string slots or (in extreme cases) raising the saddle height and resetting the neck angle.

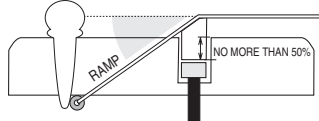

### THE 50/50 RULE

For adequate coupling between string, saddle and pickup, we recommend that the saddle slot depth (with pickup installed) should equal no more than 50% of the total height of the saddle.

### ADJUSTING FOR TOO DEEP A SADDLE SLOT

If the slot (with pickup installed) measures more than 50% of the total saddle height, the pickup performance will often suffer. To correct for too deep a slot, place a wood shim under the pickup. Determine the proper thickness of the shim by subtracting 1/2 of the total saddle height from the slot depth (with pickup installed). Then, remove an amount of material equal to the thickness of the shim from the bottom of the saddle.

**EXCEPTION:** Pickups in guitars with a very steep string break angle (25° or more), will generally perform well, even if the saddle slot depth measures more than 50% of the total saddle height.

### COMPENSATED SADDLES

We do not recommend compensating the saddle under the "B" string. Doing so may twist the saddle and cause uneven pickup response.

## PREPARE THE SADDLE SLOT

1. Rout a .125" (3.2 mm) wide saddle slot for the Acoustic Matrix Wide Format pickup.

**OR**

1. Rout a .09375" (2.3 mm) wide slot for the Acoustic Matrix Narrow Format pickup.
2. Be certain that the bottom of the slot is flat. Deepen an existing slot only enough to obtain a clean, flat surface.

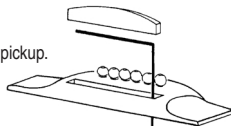

## LOCATE THE WIREHOLE

1. Locate the center of the wire hole no less than .100" (2.5 mm) from the closest string.
2. Mark the location where the wire will enter the saddle slot. Center the mark between the walls (width) of the slot.
3. Drill a .09375" hole.
4. Clear wood chips and foreign materials from the saddle slot.
5. Carefully insert (do not bend) the pickup.

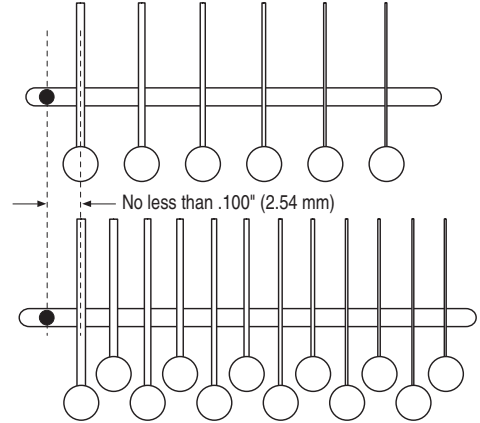

## PREPARE THE SADDLE

We recommend synthetic materials such as Micarta or Corian as excellent saddle materials for the Acoustic Matrix. Organic materials such as bone or ivory are not as consistent and may result in poor string balance.

1. Prepare a .125" wide saddle (.09375" for Narrow Format) The bottom of the saddle must be flat.
2. Remove only enough material from the width of the saddle to provide a sliding fit in the slot. To test the fit, the saddle should slide easily in the slot, but should not fall out when overturned. To maintain your current action, the new saddle must be .053" shorter in height (.043" for Narrow Format pickups) than your current saddle.

## PREAMP CUTOUT

For guitars with non-laminated sides, we strongly recommend gluing a thin plywood patch inside the guitar before cutting out the cavity. This will prevent cracking and splintering of the cut-out area during cutting, and provide adequate structural support for the preamp.

1. Choose the preamp location on the side of the instrument. Note that the bezel has the ability to conform to most curved surfaces on standard size guitars.
2. Tape the enclosed Cutout Template to the desired location. Use the flex shaft tool (with 1/2" blade) or the router (with 1/4" cutter) to make the cut-out.
3. Drill the screw mounting holes using the 1/8" drill.

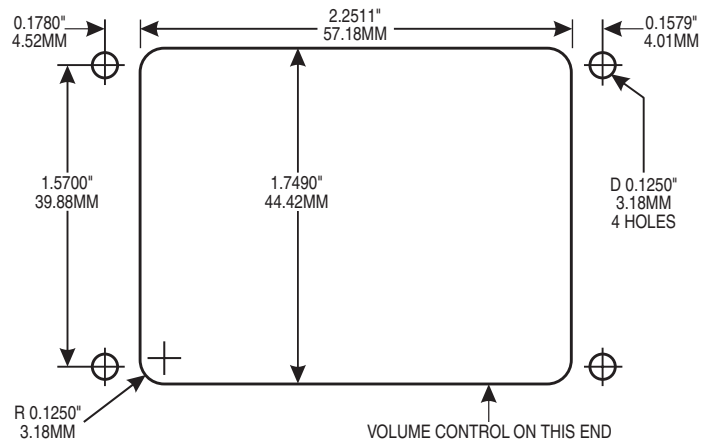

## PREPARE THE ENDPIN BLOCK

### TOOLS

- Masking Tape
- Variable Speed Drill
- 1/8" Twist Drill
- 1/2" Open End Wrench
- X-Acto Fine-toothed Saw
- Center Punch
- 15/32" Spade Bit Drill
- 3/32" Allen Wrench

The objective of this method is to drill a hole in the endblock, with the endpin in place. You may remove a loose endpin and refasten it in the endblock with cyanoacrylate glue before starting this procedure.

# FISHMAN® ACOUSTIC MATRIX™ PROFESSIONAL SYSTEM PREAMP INSTALLATION • CONTINUED

1. Apply masking tape around the endblock area to protect the instrument.
2. Locate an X-Acto saw blade 1/16" away from the body and saw off the endpin.
3. Centerpunch a guide hole in the center of the trimmed endpin.
4. Drill a 1/8" pilot hole through the endblock.
5. Line up a 15/32" Spade bit in the pilot hole and begin drilling. Maintain a perpendicular plunge in relation to the instrument. Use steady (but not heavy) pressure, especially as the drill exits inside the guitar.

**IMPORTANT:** To avoid damage to the instrument, let the drill come to a complete stop before removing it from the hole.

## SOLDER THE WIRE CONNECTIONS

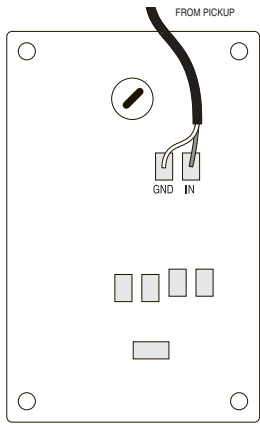

1. Insert the pickup in the saddle slot then strip and tin the wire ends.
2. Solder the "hot" wire from the pickup (inner conductor) to the pad marked "IN" on the preamp circuit board. Solder the "ground" wire from the pickup (shield) to the pad marked "GND" on the preamp circuit board.
3. Strip and tin the wire ends of the preamp output cable. Solder the red wire to TIP, the black wire to RING and the ground wire to the SLEEVE of the 1/4" jack.

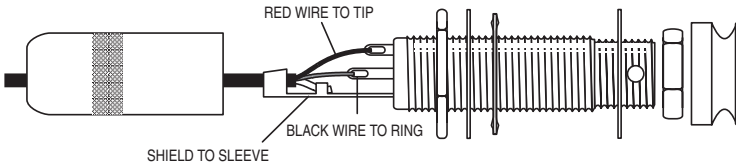

## FASTEN THE JACK IN THE ENDPIN HOLE

Follow this sequence when installing the endpin jack:

- 1 - Shielding Cap (optional)
- 2 - First Large Hex Nut
- 3 - Large Dress Washer
- 4 - Star Washer
- 5 - Guitar Endblock
- 6 - Small Dress Washer
- 7 - Small Dress Nut
- 8 - Strap Button

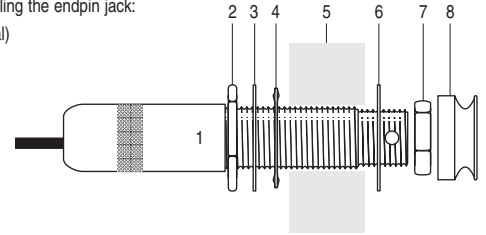

The jack should protrude at least 5/16" and no more than 11/32" outside of the body for proper fit. After fitting the small dress washer and nut over the end of the jack, insert the 3/32" allen wrench through the cross drilled hole on the end of the jack. Tighten the nut with the 1/2" open end wrench while holding the jack in place with the allen wrench. Thread and hand tighten the the strap button.

**NOTE:** With the strap button in place, the end of the jack should protrude slightly to allow proper plug fit.



## MOUNT THE PREAMP

The hardware supplied will accommodate guitars with laminated sides that are between .100" and .175" thick. If your guitar has sides less than .100" thick, the slider knobs will not fit in the bezel properly. To make up the difference, use #4-40 washers to shim the preamp inside the instrument or contact Fishman for longer standoffs.

1. Fasten the 3/16" brass hex screws and the 1/4" hex standoffs to the preamp as shown. Note that the mounting holes on the volume control side of the circuit board are slotted to allow for fitting the preamp to the curved surface of the guitar side.
2. Temporarily fit the preamp and bezel together on the guitar, with the standoffs finger tight. Fasten the bezel with the #4-40 1/2" screws to check the standoff alignment. Align the standoffs if necessary. Remove the preamp from the guitar. Tighten the aligned standoffs secure.
3. Mount the backplate to the preamp with the 3/16" #4-40 screws. Install the battery and string up the guitar.
4. Plug the guitar into an amplifier and set all the slider's tone controls to their center positions. On the back of the preamp, there is a recessed Sub-Bass control which is preset at the factory to full boost. This can be used to roll-off the amount of "bottom end" which can cause feedback (especially in larger dreadnought-style guitars). Turn the trim pot counter clockwise for less bass.
5. Re-install the preamp into the guitar. Be sure that the low battery LED lines up with the corresponding hole in the bezel.
6. Attach the adhesive backed plastic wire guides to the sides or the kerfing of the instrument.
7. Insert a 9 Volt Alkaline battery into the battery clip.

**IMPORTANT:** Although the supplied battery holder should provide adequate capacity to grip the battery at all times, we strongly recommend removal of the battery when shipping your instrument. FAILURE TO REMOVE BATTERY COULD RESULT IN DAMAGE TO YOUR INSTRUMENT. Fishman will not be held responsible for any such damage as a result of shipping or handling.

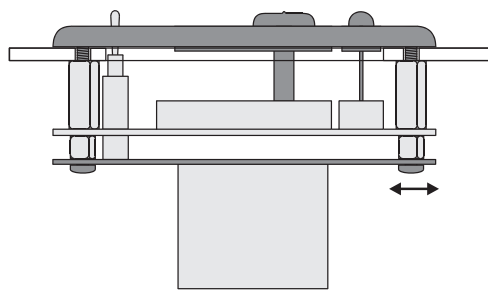
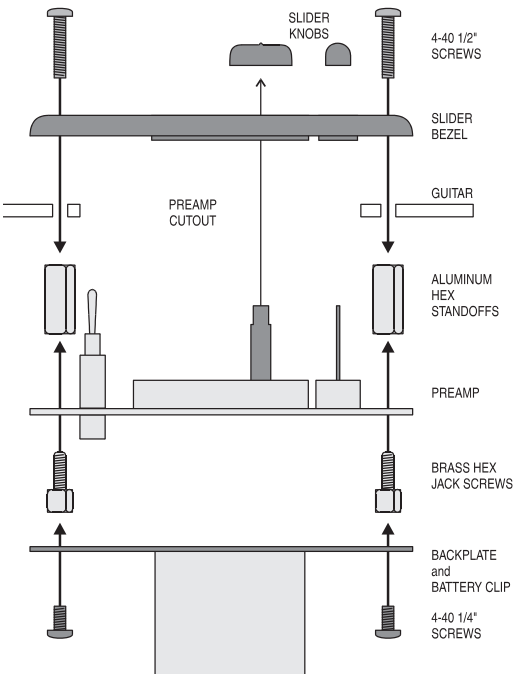

ELONGATED HOLES ALLOW FOR FITTING ASSEMBLY TO CURVATURE OF GUITAR

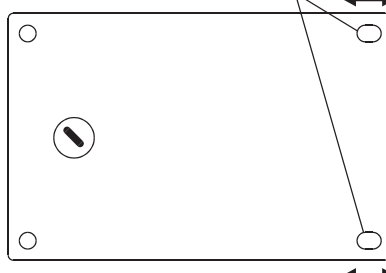

## OPERATION

The output jack of the Acoustic Matrix Professional System is also the power switch for the battery. When a cable is first plugged into this jack, the BATT/LOW LED will flash momentarily to indicate that the power is on. When the battery power is low, this light will remain lit. Be sure to unplug the output jack when not in use to avoid battery drain.

Adjust the volume of the preamp and your amplifier as desired. Using your ears as a guide, set the PHASE switch for proper phase relationship with the sound source (amps, monitors, etc.). This relationship is most audible at louder volumes and will change from room to room and with your position on stage.

**FISHMAN®**  
*Acoustic Power*

FISHMAN TRANSDUCERS  
340-D Fordham Road Wilmington MA 01887 USA  
Phone 978-988-9199 • Fax 978-988-0770 www.fishman.com